

True blue

Oil Field Project



Construction Site



Military Camp



Government Resettlement Housing



Hospital (Wuhan leishenshan)



Mine Project



Tourist Attractions



Residential



Toilet



Office



Hospital



Dormitory



Dining Room



会议厅
Meeting Room



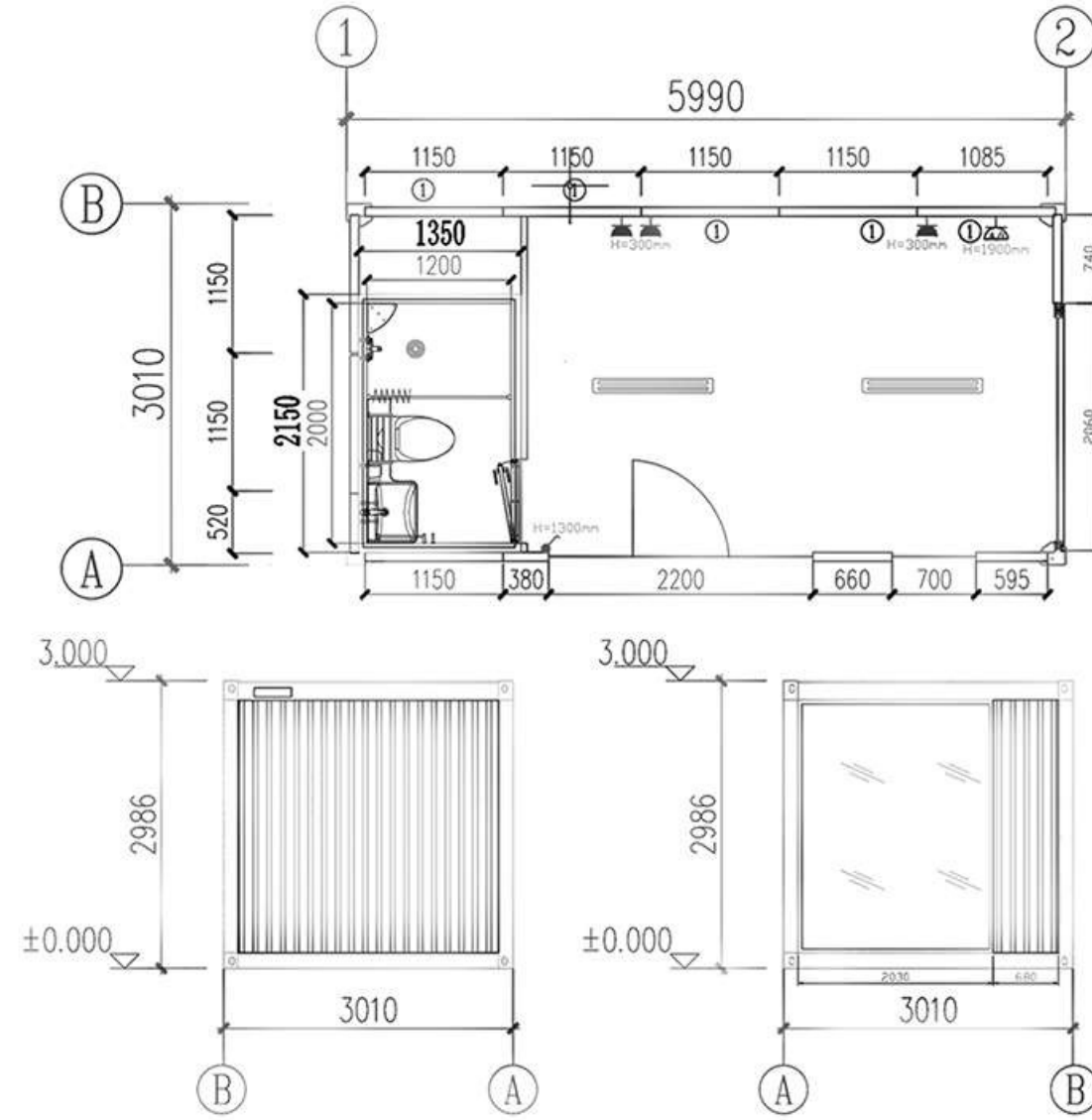

Container House

Size	9000mm*3000mm*2896mm(L*W*H) (can be customized)
Life Span	15~20years
Packing	One 40HQ can load 4units
Material	Light Steel Structure+Sandwich Panel
Installation	4 workers+3 Hours can finished one house



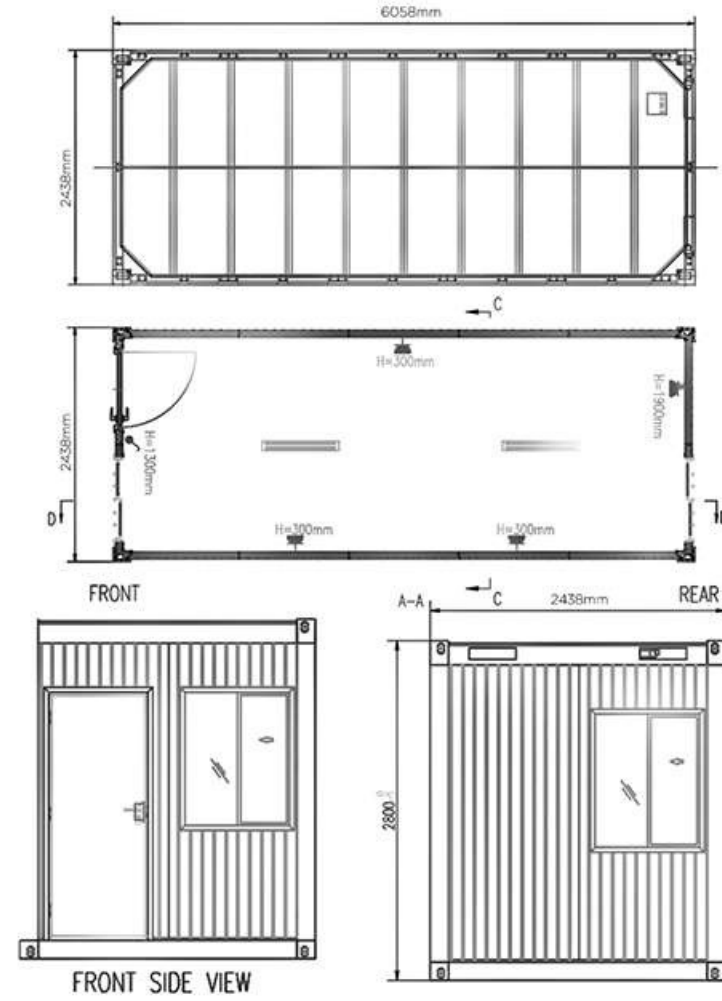

Flat Pack Container

Size	6055mm*2438mm*2896mm(L*W*H) (can be customized)
Life Span	15~20years
Packing	One 40HQ can load 10units
Material	Light Steel Structure+Sandwich Panel
Installation	4 workers+3 Hours can finished one house



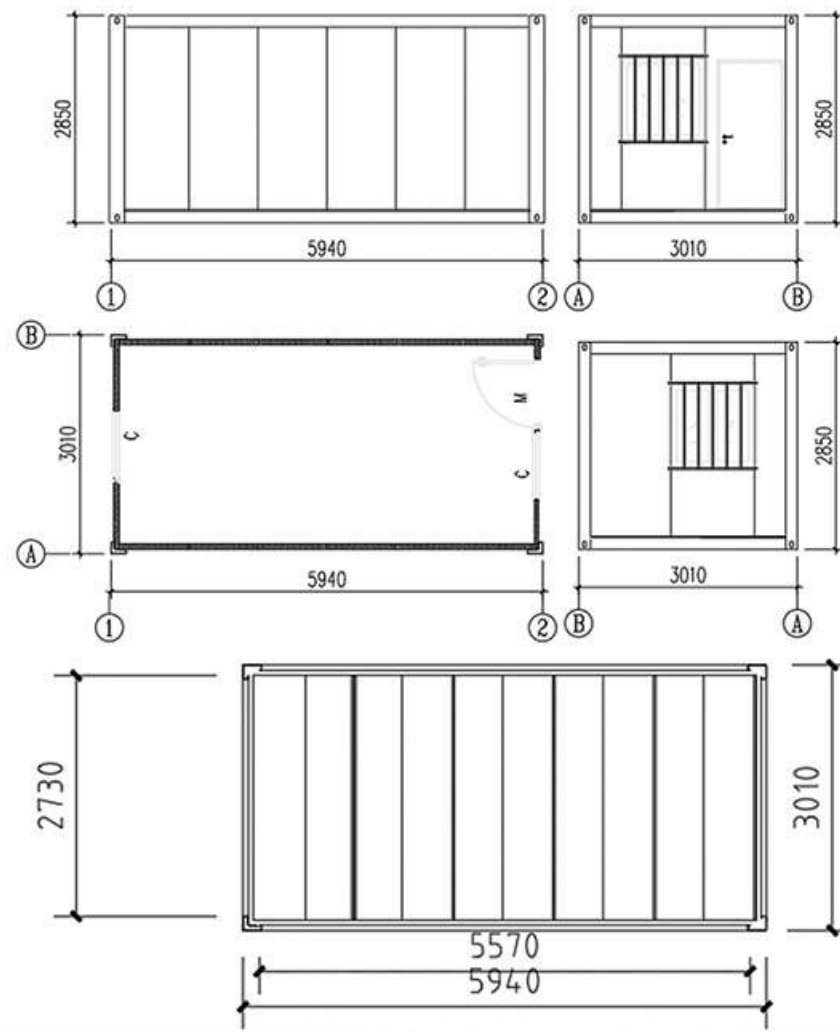

Detachable Contain

Size	5940mm*3010mm*2850mm(L*W*H) (can be customized)
Life Span	15~20years
Packing	One 40HQ can load 12units
Material	Light Steel Structure+ Sandwich Panel
Installation	4 workers+3 Hours can finished one house



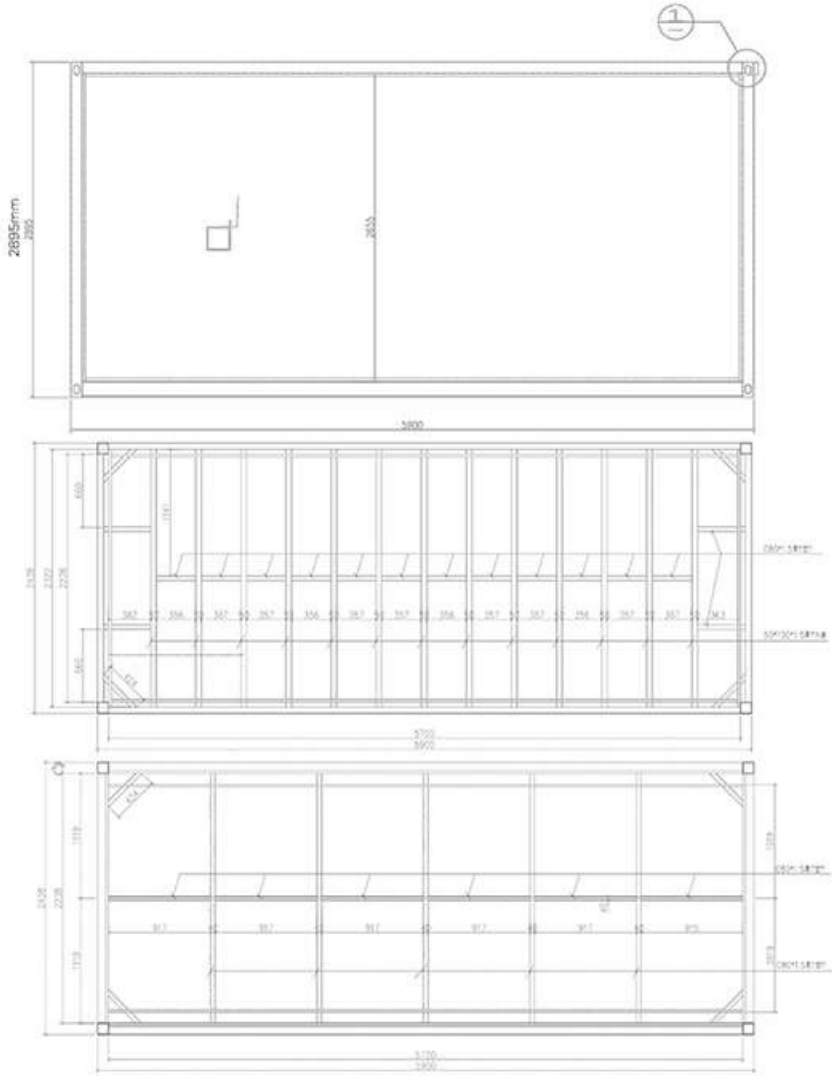

Corrugated Container

Size	5990mm*2438mm*2896mm(L*W*H) (can be customized)
Life Span	15~20years
Packing	One 40HQ can load 10units
Material	Light Steel Structure+ Sandwich Panel
Installation	4 workers+3 Hours can finished one house



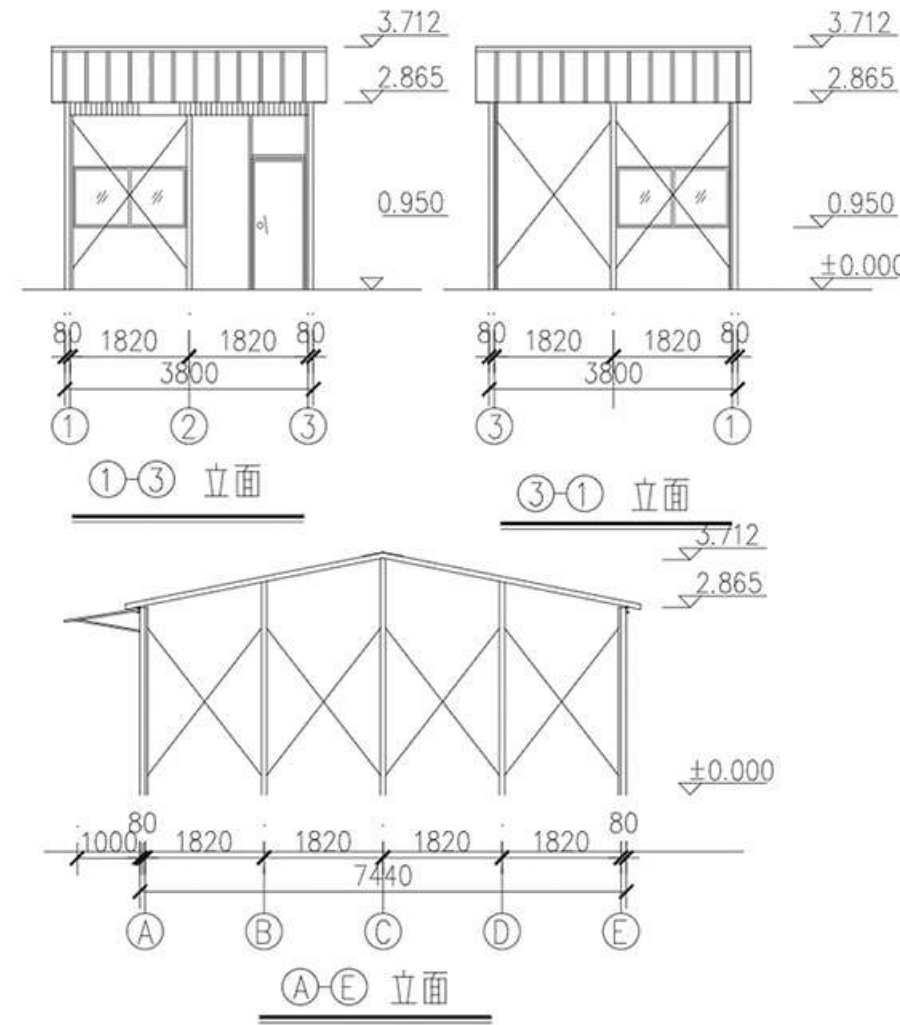

K House

Size	3K*2K (size can be customized)
Life Span	8~10years
Packing	One 40HQ can load 300 square meters
Material	Steel Structure+Sandwich Panel
Installation	4 workers+2 days can finished 120square meters

Double Slope House
>>



Four-slope House
>>



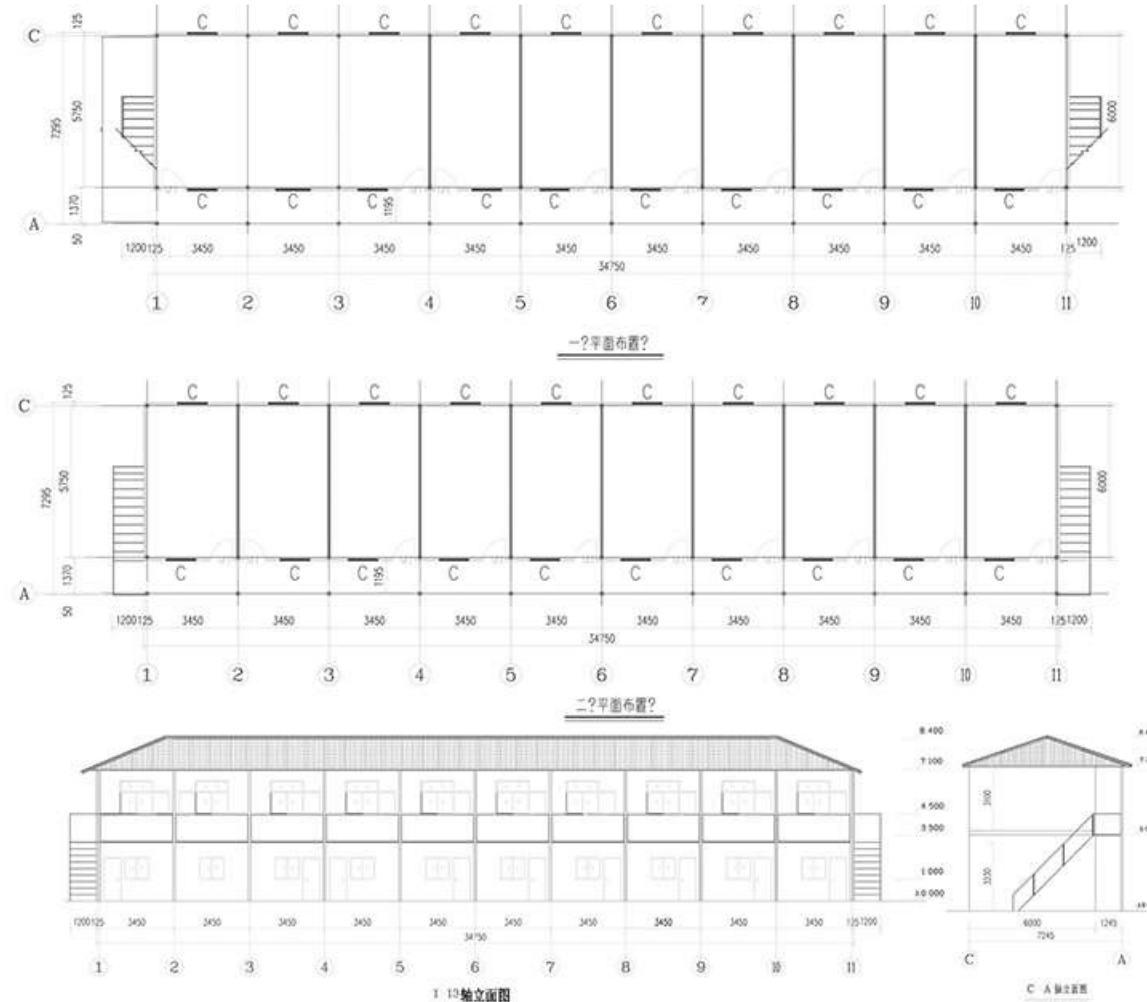

T House

Size	size can be customized
Life Span	8~10years
Packing	One 40HQ can load 300 square meters
Material	Steel Structure+Sandwich Panel
Installation	4 workers+2 days can finished 120square meters

Double Slope House
>>



Four-slope House
>>





Top Beam



Top Cross Beam



Top Corner Fitting



Bottom Beam



Rain Water Slot



Hexagon Bolt



Slide Panel Joint



Cornice (Color Steel)



Bottom Cross Beam



Bottom Corner Fitting



Corner Column



Ceiling Board



PVC Skirting



Top Frame Corner Joint



Bottom Frame Corner Joint



Corner Post Reinforcement



Bottom Module



Top Module



Wall Panel



Fiber Cement Board



Sealant Strip



PVC-U Reducer Union



Screen Window



Water Pipe Plug



Window



Door



PVC Floor

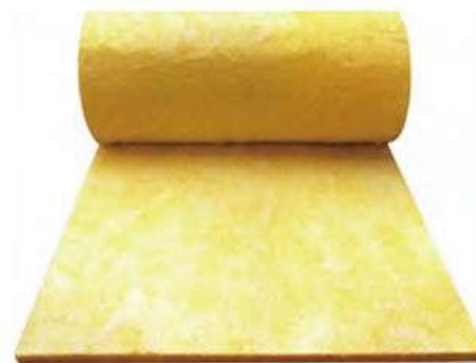

Glass Wool



U-PVC Water Pipe



Thread Rod



Riot Box



Rubber Stopper

 **OPTIONAL ACCESSORIES**



Water Tap1



Shower



Urinal



Water Tap2



Distribution Box



Emergency Exit Sign



Wire



Energy-Saving Lamp



Hand Washbasin



Squatting Pan



Flushing Tank



Mop Pool



Five Holes Socket



Switch



AC Socket



Waterproof Socket



Flushing Toilet



Mirror



Stainless Steel Wash Basin



Whole Bathroom



Fire Emergency Light



Door Closer



Drain Pipe



Service Pipe



Wall Type Heater



Ceiling Lamp



Ventilating Fan



Toilet Roll Holder



Non-Slip Mat



Floor Drain

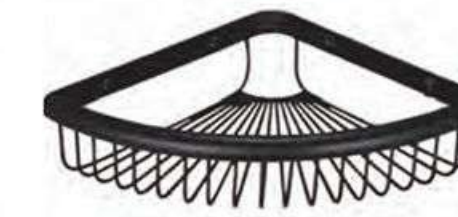

Bath Basket



Pipe Elbow